

- PLC
- HMI
- SENSOR
- ENCODER
- COUNTER
- INFORMATION

DirectSOFT

Features

Programming Software

- PLC programmer software for computers
- Easy selectable functions from pull-down menus and tool bar
- Comments and nicknames can be used for the functional memory Nos.
- Convenient online help



Features

Supports All Koyo PLCs

DirectSOFT supports all products made by Koyo Electronics including the SJ series, DL05, DL06, DL205 series, PZ series, D4 series, and D3 series. This software has incredibly abundant programming and debugging features.

Providing a Comfortable Programming Environment

If the program was written with sufficient consideration, it can prevent the user from incurring damage when machine operation stops due to failure. However, some commercially available software packages only offer environments that make it difficult to write programs. If you use our grid type program editor, you can easily and intuitively create circuit comments, element nicknames (16 characters), element descriptive texts (6 x 18 characters), and wiring information (16 characters).

Programming Over Ethernet

The user can program one or several PLC units using a computer via an Ethernet network. If an Ethernet card is installed in a user computer and the ECOM module is mounted to a supported Koyo Electronics' PLC, the user can monitor and program PLCs at high speed. Simply by starting the Ethernet setup wizard and executing the steps, the user can easily connect the PLC to the computer. All necessary functions are contained in the package.

List of Supported PLCs

You can program Koyo Electronics' PLCs using the DirectSOFT programming software. For compatibility, see the following table.

Family CPU	Direct Software	Programming
SJ Series	Sound (Version 5.1 or later is required.)	○
	Analog (Version 5.1 or later is required.)	○
	Standard (Version 5.1 or later is required.)	○
DL05	Version 2.4a or later is required.	○
DL06	Version 4.0 or later is required.	○
DL205 (SZ)	D2-230	○
	D2-240	○
	D2-250-1 (Version 4.0 or later is required.)	○
	D2-260 (Version 4.0 or later is required.)	○
	D2-265 (Version 5.1 or later is required.)	○
	SZ-3	○
	SZ-4	○
PZ Series	PZ1/2/3	○
	D4-430	○
	D4-440	○
D4 Series	D4-450	○
	SU-6M	○
D3 Series	SA-20	×
	SA-21-EX*1	○
	D3-330P*1	○
	SR-20	×
	SR-21-EX*1	○
	D3-330*1	○
	D3-340	○
	D3-350	○

*1 Host link unit (D3-232-DCU) is required.

Note: Generally, the compatible products listed above are equipped with similar functions, or exactly the same functions depending on circumstances. However, DirectSOFT has not been tested for all compatible products. Therefore, it is possible that unsupported system operations and system operations that do not operate like conventional software packages may be found.

- Common Subject Matter
- KOSTAC Safety AZ-C1
- SJ
- DL05/06
- DL205
- D4
- D3
- Programmer
- DirectSOFT
- Terminator I/O
- Process Control
- ZIP LINK

- Features
- Specifications
- Serial Connection

DirectSOFT

Specifications

PLC	
HMI	
SENSOR	
ENCODER	
COUNTER	
INFORMATION	

Common Subject Matter
KOSTAC Safety AZ-C1
SJ
DL05/06
DL205
D4
D3
Programmer
DirectSOFT
Terminator I/O
Process Control
ZIP LINK

Features
Specifications
Serial Connection

Programming Specifications

Program Editing Functions

- Point-and-Click editing on a full screen using mouse operation and icons
- The editing toolbox is equipped with functions equivalent to the icons and hot keys linked to each element
- Correct addresses, contact points, coils, and box instructions are easily searched using the instruction browser.
- Convenient Windows98/NT/2000/XP functions
Tear-off, toolbar, tool tip, long file name, well known file browser
- Project information managed by project i.e., date created, date saved, link, PLC type, project explanation, version, company name / department name / programmer name.
- Cross-references displayed on the screen
- On-screen display of the usage of group elements of 8 points, 10 points, and 16 points per line
- Preliminary defining of alias names of common items including timer and counter current values
- Program names can be entered by nickname and assigned addresses later.
- Access to the V memory (data register) by starting the memory editor of grid format
- Easy cutting and pasting of circuits by individual unit or group unit in the program
- Cutting and pasting of circuits (including description) between programs
- Elements in the program can be searched by name, address, circuit number or instruction type
- Searching constants

Document Functions

- The mnemonic of program and the comment of circuits can be exported to and imported from single CVS format files. (The file format does not have to be the DirectSOFT format.)
- Grid format editor that makes operation easy
- The use of nicknames (16 characters) for addresses makes troubleshooting and programming simple and easy.
- The use of wiring information (16 characters) enables the association of PLC addresses with panel wiring numbers.
- Detailed explanations concerning program elements can be created as descriptive text (18 characters x 6 lines).
- Comments concerning circuits can be created up to 69 characters x 20 lines each.
- Comments can be cut, copied and pasted among program elements.
- A program title page in free format can be selected at the time of printing.
- Program file import / export functions

Print Functions

- All items displayed on the screen can be printed, such as ladders, stages, and mnemonics.
- Multiple column printing
- Enlarged / Reduced print sizes
- A preview of the print can be displayed before transmitting print information to the printer.
- A custom print screen that allows the selection of only items that should be included in each print screen can be created.
- Program descriptive information such as nicknames, descriptive text, and comments of circuits can be printed.
- A cross-reference of programs and the element usage table can be printed.
- The data register contents of PLCs can be printed.

Display Functions

- Program ladder display
- Program mnemonic display
- Program stage display
- Circuit numbers or addresses can be selected in ladder displays.
- Programs can be simultaneously displayed in several formats.
- Different sections of the same program can be simultaneously displayed by a screen separation function.
- The screen area can be enlarged / reduced to make the screen easy to read.
- The display color of the items being edited, changed items that are not yet saved, and descriptions can be customized.

System Setup Functions

- The PID loops are set up using the easy-to-use dialogue box.
- DV-1000 settings
- Changing of the operation mode of the PLC
- Clearing of the PLC memory by type or batch
- Selection / Changing of the range of memory storage
- Readout of PLC input/output configuration
- Changing of the input/output number allocation (Only in the case of changeable PLCs)
- PLC communications parameters can be set via a computer port, modem or Ethernet.
- Display of PLC firmware versions

Online Operation Functions

- Online help system and list of supported CPU instructions
- DSLaunch with manager functions for centrally controlling all projects, links, and applications.
- The communication links with the PLC can be automatically created and saved including cases of modem and Ethernet use.
- The PLC communication link status is displayed in an easy-to-understand manner.
- The power flow status of program elements and the current values of timers / counters are displayed in the status mode. The status of drum steps, outputs, events, and time transients can be also displayed.
- The data display window that displays various types of elements can be customized.
- Nicknames are displayed on the data view window.
- The data view window can be saved with a name.
- The data format for displaying on the data view window (such as BCD, binary, hexadecimal notation) can be selected.
- PLC numeric values can be changed on the data view window.

Maintenance and Debugging

- Automatic error checking functions while the program is being input
- Program syntax check
- Monitoring of PLC scan time
- Execution of PLC input/output diagnosis
- Display of PLC error messages and user error messages

PC System Requirements

The minimum system requirements for running DirectSOFT on a computer are shown below.





- Pentium III class CPU, clock speed 500 MHz, CD-ROM (For starting the software)
- 32-bit application, Windows 2000, Windows XP (Pro or Home), Windows Vista (Home, Basic, Premium, 32 or 64-bit) or Windows 7 (32 or 64-bit), Windows 8 (Home, Pro and Enterprise, 32 or 64-bit) recommended. Windows 8 RT edition is NOT supported.
- RAM free space: 64 MB, and hard disk free space: 20 MB
- At least one unused serial communication port
- SVGA color monitor

- PLC
- HMI
- SENSOR
- ENCODER
- COUNTER
- INFORMATION

DirectSOFT

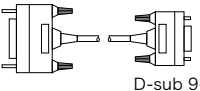
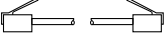
Serial Connection

List of Components

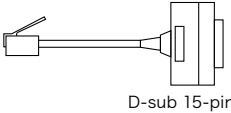
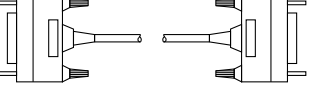
Classification / Appearance (Reference)	Model Number	Name / Function
DirectSOFT 	PC-DSOFT5	DirectSOFT Version 5.1
D-sub 15-pin Connector  D-sub 9-pin Connector	S-30JG-T	Programmer connection cable Between PLC (D-sub 15-pin) ⇔ For DOS/V
Modular 6-pin Connector Plug 	Z-20JP	Programmer connection cable (2 m)
D-sub 9-pin 	S-9CNS1	Conversion connector DOS/V ⇔ For Z-20JP
D-sub 15-pin 	S-15CNP1	Conversion connector D4 series programmer port ⇔ For Z-20JP
High-density D-sub 15-pin 	S-15HCNP1	Conversion connector DL06/D2-250-1/D2-260/PZ3 ⇔ For Z-20JP
D-sub 25-pin 	S-25CNP1	Conversion connector D4 series lower port Host link port ⇔ For Z-20JP
Modular 6-pin Connector (Plug)  D-sub 15-pin Connector (Socket)	S-15CNJ	Conversion connector cable PLC (Modular) ⇔ For S-15JP/S-30JG
D-sub 25-pin Connector (Plug)  D-sub 9-pin Connector (Plug)	S-30JD-T	Programmer connection cable For host link module (3 m) DOS/V

Operation Manual

The DirectSOFT operation manual can be downloaded from our website free of charge.

- Common Subject Matter
- KOSTAC Safety AZ-C1
- SJ
- DL05/06
- DL205
- D4
- D3
- Programmer
- DirectSOFT**
- Terminator I/O
- Process Control
- ZIP LINK
- Features
- Specifications
- Serial Connection**

DirectSOFT

Serial Connection

- PLC
- HMI
- SENSOR
- ENCODER
- COUNTER
- INFORMATION

- Common Subject Matter
- KOSTAC Safety AZ-C1
- SJ
- DL05/06
- DL205
- D4
- D3
- Programmer
- DirectSOFT
- Terminator I/O
- Process Control
- ZIP LINK

- Features
- Specifications
- Serial Connection

Connection

Connection Between DirectSOFT and the SJ/DL05/DL06/DL205/SZ/D4 PLC

Modular

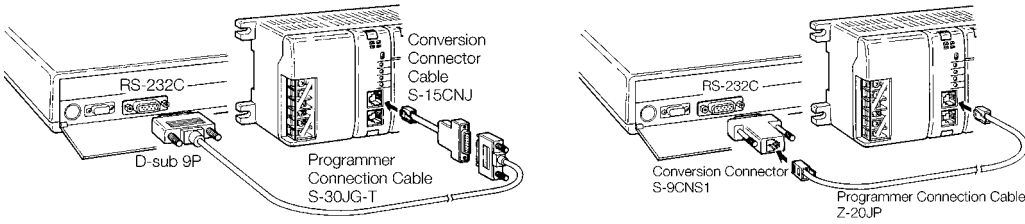

High-density D-sub 15-pin

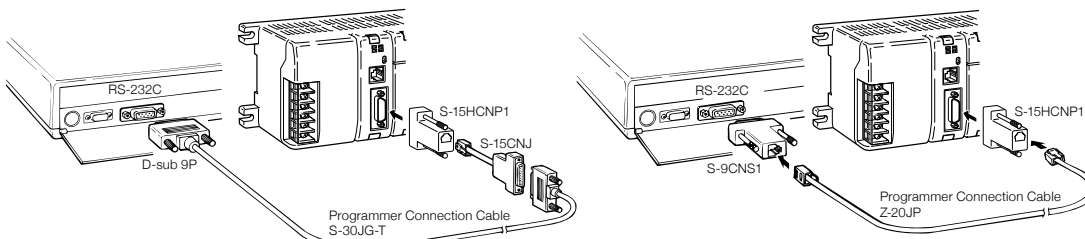

Connection Between DirectSOFT and the D4 Series/SU-6M

Programmer port (D-sub 15P)

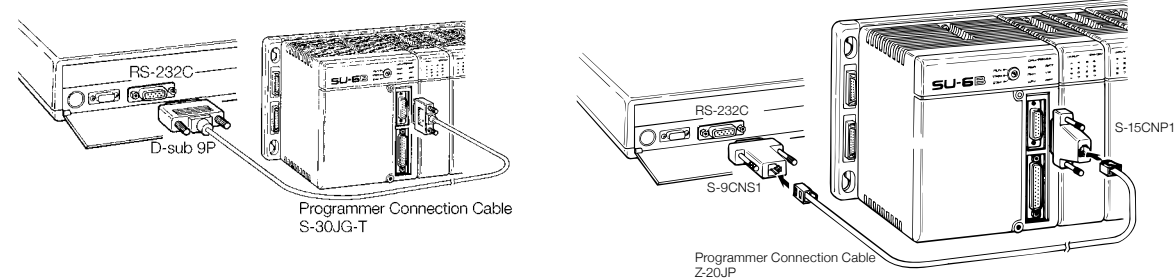

Lower port (D-sub 25P) and host link module (D-sub 25P)

* The connection method of the host link is shown below as an example, but the same applies to the lower port.

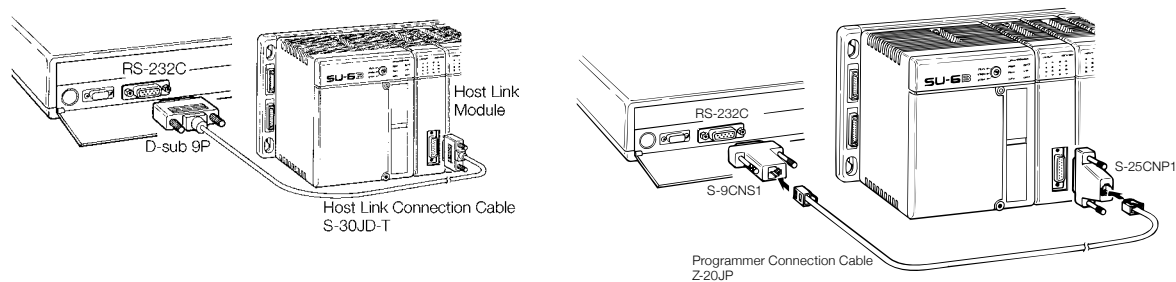

Connection Between DirectSOFT and the D3 Series

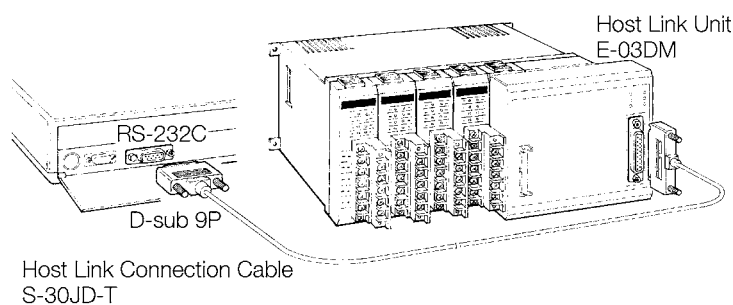

- PLC
- HMI
- SENSOR
- ENCODER
- COUNTER
- INFORMATION

DirectSOFT

Serial Connection

List of Cables

Since the CPU is equipped with various kinds of communication ports, correctly check the necessary communication cables.

Select appropriate cables by referring to the table below.

Family	CPU (Or Other Device)	Port	Cable	Supported Protocol				
				Direct Net (CCM2)	K-sequence	ECOM	MODBUS	
SJ Series	SJ CPU	Port 1	Z-20JP+S-9CNS1		○			
		Port 2	Z-20JP+S-9CNS1	○	○		○	
DL05	DL05 (All versions)	Port 1	Z-20JP+S-9CNS1		○			
		Port 2	Z-20JP+S-9CNS1	○	○		○	
	H0-ECOM (Module)	Only 1 port	Commercial LAN cable 10Base-T			○		
DL06	DL06 (All versions)	Port 1	Z-20JP+S-9CNS1		○			
		Port 2	S-9CNS1+Z-20JP+S-15HCNP1	○	○		○	
	H0-ECOM (Module)	Only 1 port	Commercial LAN cable 10Base-T			○		
DL205 Series	DL205 Series	D2-230	Only 1 port	Z-20JP+S-9CNS1		○		
		D2-240	Top port	Z-20JP+S-9CNS1		○		
			Bottom port	Z-20JP+S-9CNS1	○	○		
		D2-250-1	Top port	Z-20JP+S-9CNS1		○		
		D2-260, D2-265	Bottom port	S-9CNS1+Z-20JP+S-15HCNP1	○	○		○
		D2-DCM (Module)	Only 1 port	S-9CNS1+Z-20JP+S-25CNP1 S-30JD-T	○	○		○
		D2-265	Port 3	Commercial LAN cable 10Base-T			○	
		H2-ECOM100 (Module)	Only 1 port	Commercial LAN cable 10Base-T			○	
D4 Series	D4 Series	D4-430	Top port (15-pin)	S-30JG-T		○		
		D4-440	Bottom port (25-pin)	S-9CNS1+Z-20JP+S-25CNP1 S-30JD-T	○	○		
			Top port (15-pin)	S-30JG-T		○		
		D4-450 SU-6M	Bottom port (25-pin)	S-9CNS1+Z-20JP+S-25CNP1 S-30JD-T	○	○		○
			Modular terminal	Z-20JP+S-9CNS1	○	○		
		D4-DCM (Module)	Only 1 port	S-9CNS1+Z-20JP+S-25CNP1 S-30JD-T	○	○		○
D3 Series	D3 Series	H4-ECOM100 (Module)	Only 1 port	Commercial LAN cable 10Base-T			○	
		D3-232-DCU (Module)	Only 1 port	S-9CNS1+Z-20JP+S-25CNP1 S-30JD-T	○	○		○
		D3-340	Top port	D3-DSCBL-1	○	○		
			Bottom port	D3-DSCBL-1	○	○		○
		D3-350	Top port	Z-20JP+S-9CNS1	○	○		
	Bottom port	S-9CNS1+Z-20JP+S-25CNP1 S-30JD-T	○	○		○		

- Common Subject Matter
- KOSTAC Safety AZ-C1
- SJ
- DL05/06
- DL205
- D4
- D3
- Programmer
- DirectSOFT
- Terminator I/O
- Process Control
- ZIP LINK

- Features
- Specifications
- Serial Connection

DirectSOFT

Serial Connection

- PLC
- HMI
- SENSOR
- ENCODER
- COUNTER
- INFORMATION

- Common Subject Matter
- KOSTAC Safety AZ-C1
- SJ
- DL05/06
- DL205
- D4
- D3
- Programmer
- DirectSOFT
- Terminator I/O
- Process Control
- ZIP LINK

- Features
- Specifications
- Serial Connection

Connection

The pin labels comply with the IBM DTE specifications and the DCE specifications.

Z-20JP+S-9CNS1

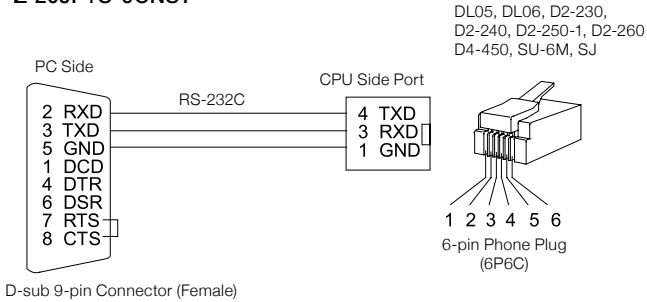

S-9CNS1+Z-20JP+S-15HCNP1

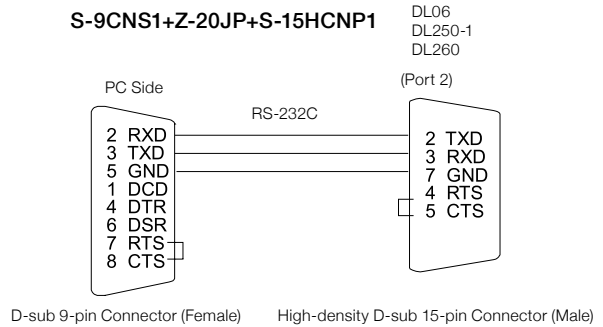

S-9CNS1+Z-20JP+S-15CNP1 or S-30JG-T

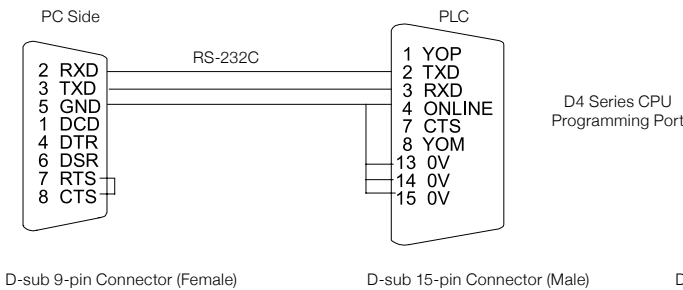

S-9CNS1+Z-20JP+S-25CNP1 or S-30JD-T

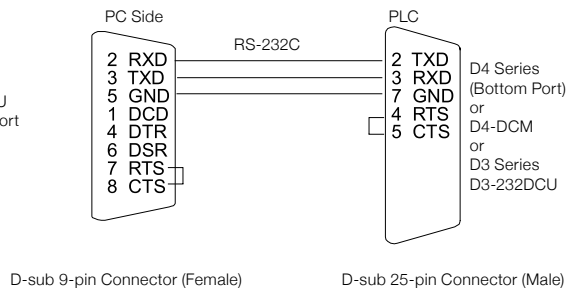

Straight Cable

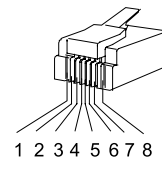
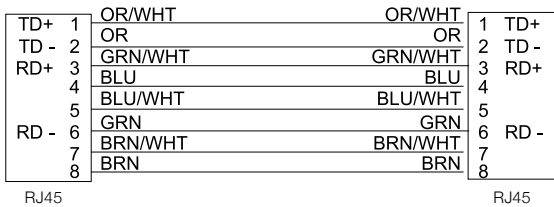

8-pin RJ45 Connector (8P8C)

All Ethernet and Ecom cables are category 5 UTP cables. The appropriate wiring position of the RJ45 connector is shown in this figure.

Crossover Cable

